

Features :

- Highest Flux White
- High reliability and Very long operating life (up to 100K hours)
- Low voltage DC operated
- More Energy Efficient than Incandescent and most Halogen lamps
- NO UV
- Superior ESD protection
- RoHS Compliant

Typical Applications :

- Reading lights (car, bus, aircraft)
- Portable (flashlight, bicycle)
- Automotive Exterior (Stop-Tail-Turn, CHMSL, Mirror Side Repeat)
- Decorative

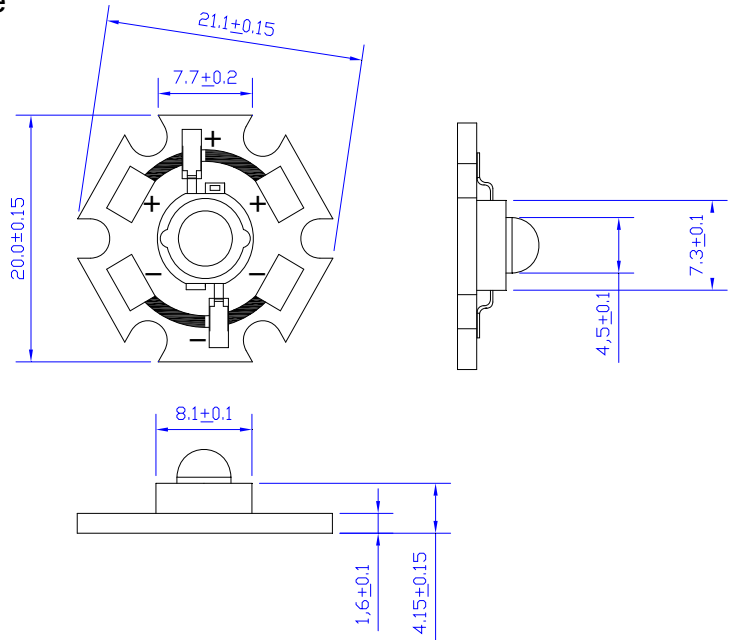

NOTE:

- All dimensions are millimeter.
- Tolerance is $\pm 0.25\text{mm}$ unless noted

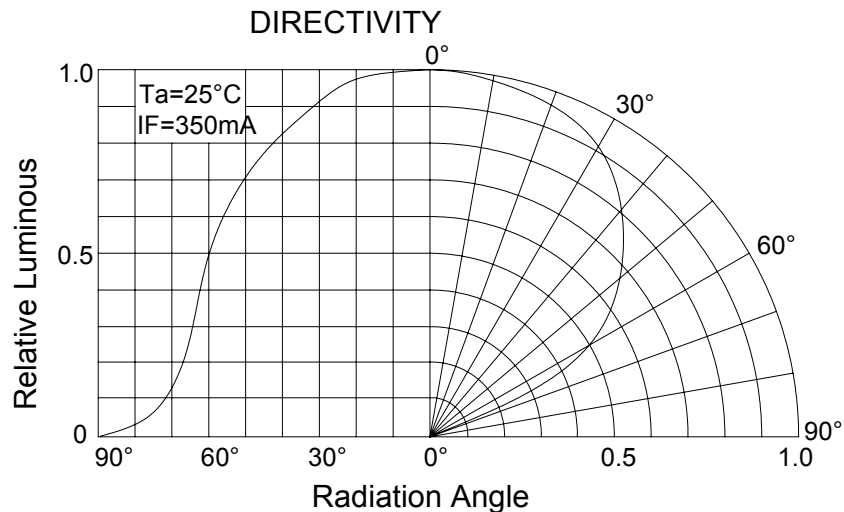



Part No. : **S12PW6C**

Absolute maximum ratings (Ta = 25)

Parameter	Symbol	Test Condition	Value		Unit
			Min.	Max.	
DC Forward Current	IF	----	----	350	mA
Peak Pulse Current	Ipeak	Duty=0.1ms , 1kHz	----	500	mA
Power Dissipation	Pd	----	----	1.4	W
LED Junction Temperature	Tj	----	----	120	
Operating Temperature	Topr	----	-25	+100	
Storage Temperature	Tstr	----	-40	+120	
ESD Sensitivity	---	HBM	8000	----	V
Soldering Temperature	---	----	260 for 5 Seconds max		

Electrical and optical characteristics (Ta = 25)

Parameter	Symbol	Test Condition	Value			Unit
			Min.	Typ.	Max.	
Forward Voltage	VF	IF = 350mA	3	3.4	4.0	V
Luminous Flux	v		50	----	----	lm
Viewing Angle	2 1/2		----	120	----	Deg.
Color Temperature	CCT		----	6000	----	K

Luminous Flux Bins (Ta = 25)

Unit: lm

Bin	J	K	L
Min	50	60	70
Max	60	70	80

CCT Bins (Ta = 25)

Unit: K

Bin	W0	W1	W2
Min	----	6000	6500
Max	6000	6500	8000